

# Intelligent Controller LNL-M4420 with Two Reader Interfaces Quick Reference

## General

The LNL-M4420 intelligent controller provides decision making, event reporting, and database storage for the LenelS2 hardware platform. Two reader interfaces provide control for two doors.

The LNL-M4420 communicates with the host via on-board 10Base-T/100Base-TX Ethernet port or the Micro USB port (2.0) with an optional Micro USB to Ethernet adapter.

Two physical barriers can be controlled with the LNL-M4420. Each reader port can accommodate a read-head that utilizes TTL (D1/D0, Clock/Data), F/2F or 2-wire RS-485 electrical signaling (OSDP reader for example) and also provides tri-state LED control and buzzer control (one wire LED mode only). Four Form-C relay outputs may be used for door strike control or alarm signaling. Eight inputs are provided for monitoring the door contacts, exit push buttons, and alarm contacts. Input circuits can be configured as unsupervised or supervised. The LNL-M4420 requires 12 to 24 VDC for power.

## LNL-M4420 Hardware

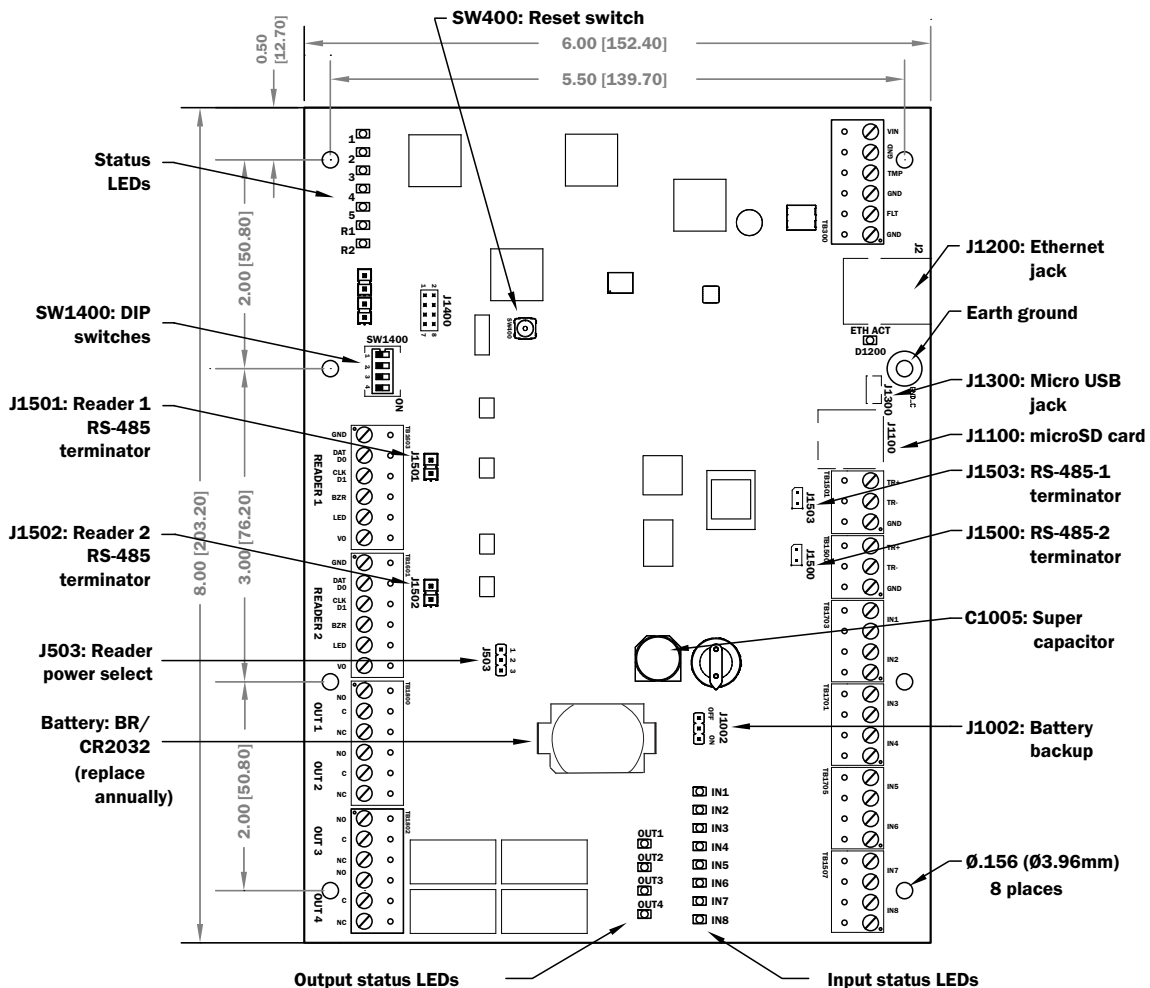

## LNL-M4420 Wiring

Terminal Block Connections		
TB300-1	Power Fault Input	GND
TB300-2		FLT
TB300-3	Cabinet Tamper Input	GND
TB300-4		TMP
TB300-5	Power Input	GND
TB300-6		VIN: 12 to 24 VDC
TB1501-1	SIO Port 1 (2-wire RS-485)	GND
TB1501-2		TR- (B) *
TB1501-3		TR+ (A) *
TB1500-1	SIO Port 2 (2-wire RS-485)	GND
TB1500-2		TR- (B) *
TB1500-3		TR+ (A) *
TB1703-1	Input 2	IN2
TB1703-2		IN2
TB1703-3	Input 1	IN1
TB1703-4		IN1
TB1701-1	Input 4	IN4
TB1701-2		IN4
TB1701-3	Input 3	IN3
TB1701-4		IN3
TB1705-1	Input 6	IN6
TB1705-2		IN6
TB1705-3	Input 5	IN5
TB1705-4		IN5
TB1707-1	Input 8	IN8
TB1707-2		IN8
TB1707-3	Input 7	IN7
TB1707-4		IN7

\* Terms A & B are from the RS-485 standard.

Terminal Block Connections		
TB1603-1	Reader 1	GND: Ground
TB1603-2		DAT/D0: Data/ Data 0/TR- (A) *
TB1603-3		CLK/D1: Clock/ Data 1/TR+ (B) *
TB1603-4		BZR: Reader Buzzer
TB1603-5		LED: Reader LED
TB1603-6		VO: Reader Power
TB1601-1	Reader 2	GND: Ground
TB1601-2		DAT/D0: Data/ Data 0/TR- (A) *
TB1601-3		CLK/D1: Clock/ Data 1/TR+ (B) *
TB1601-4		BZR: Reader Buzzer
TB1601-5		LED: Reader LED
TB1601-6		VO: Reader Power
TB1800-1	Out 1	NO: Normally Open Contact
TB1800-2		C: Common
TB1800-3		NC: Normally Closed Contact
TB1800-4	Out 2	NO: Normally Open Contact
TB1800-5		C: Common
TB1800-6		NC: Normally Closed Contact
TB1802-1	Out 3	NO: Normally Open Contact
TB1802-2		C: Common
TB1802-3		NC: Normally Closed Contact
TB1802-4	Out 4	NO: Normally Open Contact
TB1802-5		C: Common
TB1802-6		NC: Normally Closed Contact

## Jumpers and Jacks

The LNL-M4420 processor hardware interface is configured using jumpers to set up the reader port power and end of line termination.

Jumpers	Set at	Description
J1200	N/A	10Base-T/100Base-Tx Ethernet Connection (Port 0)
J1503	OFF	Port 1 RS-485 EOL Terminator is Off
	ON	Port 1 RS-485 EOL Terminator is On
J1500	OFF	Port 2 RS-485 EOL Terminator is Off
	ON	Port 2 RS-485 EOL Terminator is On
J1501	OFF	Reader 1 RS-485 EOL Terminator is Off (Non-OSDP readers)
	ON	Reader 1 RS-485 EOL Terminator is On (OSDP readers)
J1502	OFF	Reader 2 RS-485 EOL Terminator is Off (Non-OSDP readers)
	ON	Reader 2 RS-485 EOL Terminator is On (OSDP readers)
J1300	N/A	Micro USB Port (2.0)
J503	Reader Power Select *	
	12V	12 VDC at Reader Ports
	PASS	VIN "Pass Through" to Reader Ports
J1100	N/A	microSD Card
J1400-1	N/A	Remote Status LED #1 **
J1400-2	N/A	Remote Status LED #2 **
J1400-3	N/A	Remote Status LED #3 **
J1400-4	N/A	Remote Status LED #4 **
J1002	Super capacitor or battery backup real time clock	
	OFF	Backup battery is OFF
	ON	Backup battery is ON. Default J1002 link 1 and 2 for super capacitor real time clock backup. Link 2 and 3 for battery backup. Refer to <a href="#">Memory and Real Time Clock Backup Battery</a> on page 8.

\* For regulated reader output, install J503 jumper link in the 12V position (1 and 2) ONLY if the input voltage (VIN) is greater than 17 VDC. Failure to do so may damage the reader or LNL-M4420.

\*\*Observe polarity connection to LED. External current limiting is not required.

## DIP Switches

The four switches on SW1400 DIP switch configure the operating mode of the LNL-M4420 processor. DIP switches are read on power-up except where noted.

Pressing reset switch SW400 causes the LNL-M4420 to reboot.

1	2	3	4	Definition
OFF	OFF	OFF	OFF	Normal operating mode.
ON	X	OFF	OFF	After initialization, enable default User Name (admin) and Password (password). The switch is read on the fly, no need to re-boot. For more information refer to <a href="#">IT Security</a> on page 9.
OFF	ON	OFF	OFF	Use factory default communication parameters. *
ON	ON	OFF	OFF	Use LenelS2 default communication parameters. * Contact system manufacturer for details. See <a href="#">Bulk Erase Configuration Memory</a> on page 4.
ON	ON	OFF	OFF	Bulk Erase prompt mode at power up. See <a href="#">Bulk Erase Configuration Memory</a> on page 4.
X	X	X	ON	Makes the LNL-M4420 report and function like an LNL-X4420. To be used in situations where the host software has not been updated to support the LNL-M series product line.

X = ON or OFF. All other switch settings are unassigned and reserved for future use.

\* In the factory or LenelS2 default modes, downloaded configuration/database is not saved to flash memory.

### Factory Default Communication Parameters

Interface 1 (NIC1)

- Network: static IP address: 192.168.0.251
- Subnet Mask: 255.255.0.0
- Default Gateway: 192.168.0.1
- DNS Server: 192.168.0.1
- Primary Host port: IP server, Data Security: TLS if Available, port 3001, communication address: 0
- Alternate Host Port: Disabled

## Bulk Erase Configuration Memory

The bulk erase function can be used for the following purposes:

- Erase all configuration and cardholder database (sanitize board, less third party applications)
- Update OEM default parameters after OEM code has been changed
- Recover from database corruption causing LNL-M4420 board to continuously reboot

If clearing the memory does not correct the initialization problem, contact LenelS2 OnGuard Technical Support.

### Bulk Erase Steps

**Important:** Do not remove power during steps 1-6.

1. Set SW1400 DIP switches: 1 & 2 "ON" and 3 & 4 "OFF."
2. Apply power to the LNL-M4420 board. LED 1 will flash during boot up.
3. After boot up, LEDs 1 & 2, and 3 & 4 start to alternately flashing at a 0.5 second rate. Within 10 seconds, change switch 1 to "OFF."
4. When complete, only LEDs 1 and 4 will flash for about three (3) seconds.
5. The LNL-M4420 reboots and will be available at the default IP address (192.168.0.251).

## Input Power, Cabinet Tamper, and UPS Fault Input Wiring

The LNL-M4420 requires 12 to 24 VDC power. Locate power source as close to the unit as possible.

**Connect power with minimum of 18 AWG wire. Connect the GND signal to earth ground in ONE LOCATION within the system. Multiple earth ground connections may cause ground loop problems and is not advised.**

**Observe POLARITY on 12 to 24 VDC input.**

There are two dedicated inputs for cabinet tamper and UPS fault monitoring. Normal (safe) condition is a closed contact. If these inputs are not used, install a jumper wire.

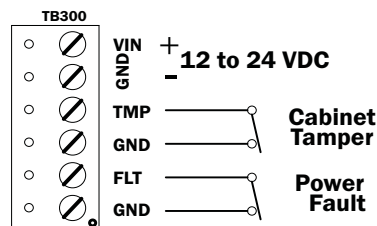

---

**Note:** For UL compliance, only 12 VDC was evaluated.

---

## Communication Wiring

The LNL-M4420 controller communicates to the host via the on-board Ethernet 10Base-T/100Base-TX port and/or the Micro USB port (2.0) with an optional Micro USB to Ethernet adapter.

The serial I/O device communication ports, TB1501 for port 1 and TB1500 for port 2, are 2-wire RS-485 interface which can be used to connect additional I/O panels. The interface allows multi-drop communication on a single bus of up to 4,000 feet (1,219 m). Use 1-twisted pair, grounded shielded cable, 120 ohm impedance, 24 AWG, 4,000 ft. (1,219 m) maximum for communication.

**Important:** Install the termination jumper ONLY on the panel at each end of the RS-485 bus. Failure to do so will compromise the proper operation of the communication channel.

*Port 1: To Serial I/O Devices*

*Port 2: To Serial I/O Devices*

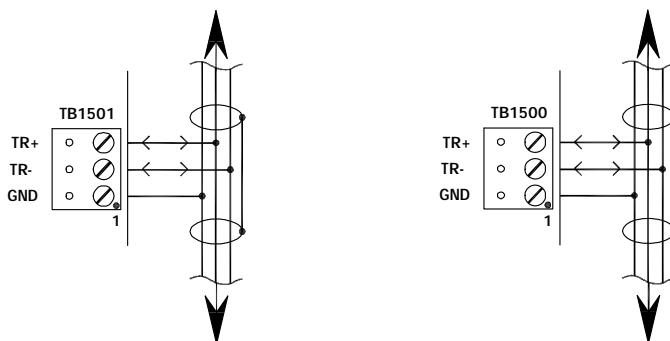

## Reader Wiring

Each reader port supports a reader with TTL (D1/D0, Clock/Data), F/2F (standard or supervised) or 2-wire RS-485 signaling (OSDP reader for example). Power to the readers is selectable: 12 VDC (VIN must be greater than 18 VDC), or power is passed-through (PASS) from the input voltage of the LNL-M4420 (TB300-VIN), 600 mA maximum per reader port. Readers that require different voltage or have high current requirements must be powered separately. Refer to the reader manufacturer’s specifications for cabling requirements. In the 2-wire LED mode, the buzzer output is used to drive the second LED. Reader port configuration is set via the host software. Do not terminate any RS-485 devices connected to a reader port.

REX input should use grounded shielded cable.

To fully utilize each reader port:



- TTL signaling requires a 6-conductor cable (18 AWG)
- F/2F signaling requires a 4-conductor cable
- RS-485 signaling requires two 2-conductor cables. Use one cable for power (18 AWG, 1-pair) and one cable for communication (24 AWG, 1-pair, shielded)

**Notes:** For OSDP communication, install jumper link to J1501 (Reader 1 RS-485 termination end) and jumper link to J1502 (Reader 2 RS-485 termination end) to enable the on-board 120 ohm termination. These jumpers should be closed when using OSDP and open for non-OSDP readers.

Data 0 and Data 1 wires for Wiegand may be reused for OSDP. However, standard Wiegand cable may not meet RS-485 twisted pair recommendations. The reuse of cable works best on shorter cable lengths at lower data rates.

**Important:** Failure to correctly set the OSDP jumper settings can cause communication issues.

### Reader Power Select (J503)

12V PASS	J503 Reader Power Select
	12 VDC is available on reader ports (VIN is greater than 17 VDC).
	VIN power is “passed through” (PASS) to reader ports.





**Important:** For 12 VDC regulated reader output, install J503 jumper link in the 12V position (1 and 2) ONLY if the input voltage (VIN) is greater than 17 VDC.

**Notes:** Install J503 jumper link 1 and 2 to regulate reader output or pass-through automatically depending on the input voltage:

- VIN 26.4 V to 17 V = 12 V Output
- VIN 17 V to 14.5 V = Output OFF
- VIN 14.5 V to 10.8 V = Pass-through

Install J503 jumper link 2 and 3 for pass-through from 26.4 V to 10.8 V.

Ensure the pass-through voltage does not exceed the reader maximum operating voltage.

Input Power	Reader Power Select (Jumper J503)	Reader Output
24 VDC	Pass-through 	24 VDC
24 VDC	12 VDC PASS 	12 VDC
12 VDC	Pass-through 	12 VDC
12 VDC	12 VDC PASS* 	12 VDC

\* For UL compliance, only 12 VDC was evaluated; pass-through was not evaluated.

## Reader Wiring Diagrams

Typical D1/D0 or Clock/Data Reader

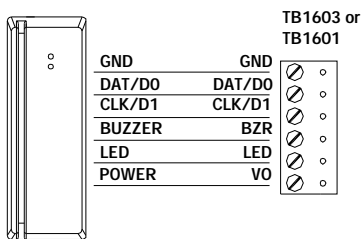

Typical 2-wire RS-485 Device (such as OSDP Reader)

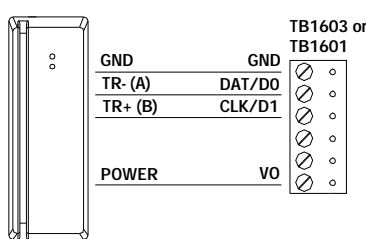

Typical Unsupervised F/2F Reader

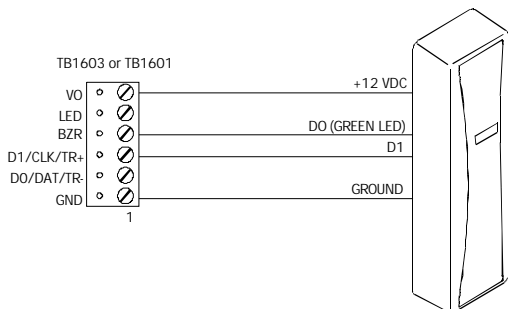

Typical Supervised F/2F Reader

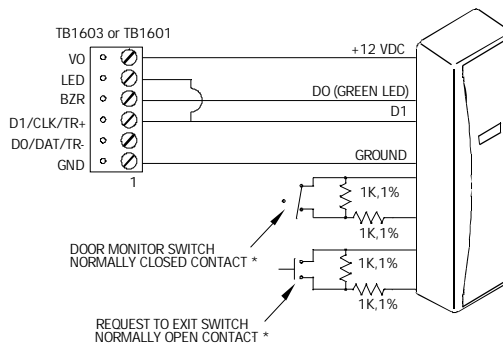

Jumper: Connect D1 and LED on supervised F/2F reader

\* Inputs on supervised F/2F readers may be unsupervised or supervised (supervised shown).

## Input Circuit Wiring

There are eight (8) inputs that are typically used to monitor door position, request to exit, or alarm contacts. Input circuits can be configured as unsupervised or supervised. When unsupervised, reporting consists of only the open or closed states. When configured as supervised, the input circuit will report not only open and closed, but also open circuit, shorted, grounded,\* and foreign voltage.\* A supervised input circuit requires two resistors be added to the circuit to facilitate proper reporting. The standard supervised circuit requires 1k ohm, 1% resistors and should be located as close to the sensor as possible. Custom end of line (EOL) resistances may be configured via the host software.

\* Grounded and foreign voltage states are not a requirement of UL 294 and therefore not verified by UL.

The input circuit wiring configurations shown are supported but may not be typical.

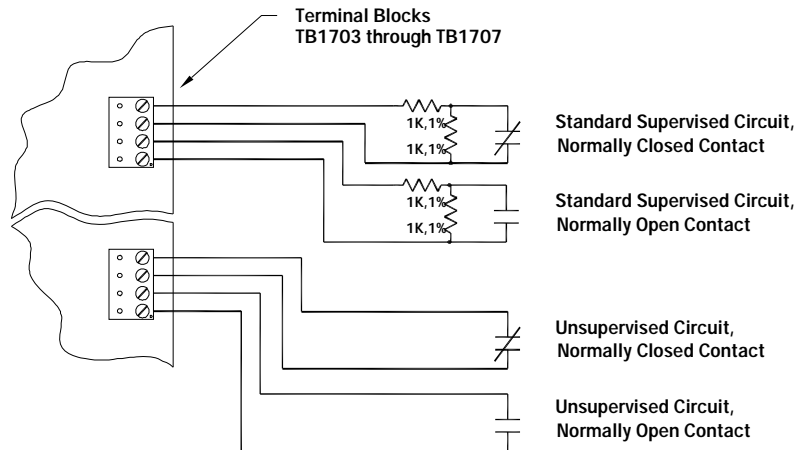

## Relay Circuit Wiring

Four (4) relays with Form-C contacts (dry) are provided for controlling door lock mechanisms or alarm signaling. Each relay has a Common pole (C), a Normally Open pole (NO) and a Normally Closed pole (NC). When controlling the delivery of power to the door strike, the Normally Open and Common poles are typically used. When momentarily removing power to unlock the door, as with a magnetic lock, the Normally Closed and Common poles are typically used. Check with local building codes for proper egress door installation.

Door lock mechanisms can generate feedback to the relay circuit that can cause damage and premature failure of the relay plus affect the operation of the LNL-M4420. For this reason, it is recommended that a diode be used to protect the relay. Wire should be of sufficient gauge to avoid voltage loss.

### Diode Selection

- Diode current rating: 1x strike current.
- Diode breakdown voltage: 4x strike voltage.
- For 12 VDC or 24 VDC strike, diode 1N4002 (100V/1A) typical.

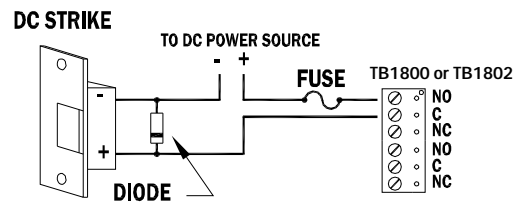

## Memory and Real Time Clock Backup Battery

The real time clock is backed up by a super capacitor or optional lithium battery when input power is interrupted. All other data is stored in non-volatile flash memory.

---

**Note:** If using the optional lithium battery, replace it annually.

---

The super capacitor is selected by default (J1002 jumper link 1 and 2).

To change to battery back up, install jumper link 2 and 3 and install the lithium coin cell.

Battery type: Panasonic BR2032 or CR2032.

---

**Note:** Data is stored in flash memory to prevent loss of data in the case of power interruption.

---



## IT Security

When installing the LNL-M4420, it is important to ensure that it is done in a secure manner. Create user accounts to the web configuration page using secure passwords.

Ensure all DIP switches are in the OFF position for the normal operating mode.

The LNL-M4420 is shipped from the factory with a default login account, which is enabled when DIP 1 is moved from OFF to ON. The default login user name (admin) and password (password) will be available for five minutes once the DIP switch is toggled. Therefore, it is important that at least one user account is defined, and the DIP switches are set to OFF before the LNL-M4420 is commissioned. It is also highly recommended **not** to configure the LNL-M4420 with an IP address that is accessible from the public Internet.

To further enhance network security, options are available to disable SNMP, Zeroconf discovery, as well as the web configuration module itself. Additionally, data encryption can be enabled over the host communication port.

## Status LEDs

### Power-up

NIC LED blinks and all other LEDs are off.

### Initialization

The initialization process has several stages, each stage is represented by a different LED pattern in the following sequence:

- LED 1 is on for about 10 seconds.
- LED 2 is on for 25 seconds.
- LED 3 flashes slowly for 15 seconds.
- LED 3 flashes quickly for 1 second. LED 3 may continue flashing for an additional 60 seconds if the controller firmware is being updated.
- LED 1, LED 2, and LED 3 are off as the application starts.
- LED 4 is then on for 15 seconds indicating a successful initialization.

When LEDs 1, 2, 3, and 4 flash at the same time, data is being read from or written to flash memory, do not cycle power when in this state. If the sequence stops or repeats, perform [“Bulk Erase Steps”](#) on page 4.

### Running

After initialization is complete, the LEDs have the following meanings:

LED	Description
1	Off-line / On-line and battery status
	Off-line = 20% ON, On-line = 80% ON
	Double flash if battery is low
2	Host communication activity (Ethernet)
3	Internal SIO communication activity
4	External SIO communication activity (Port 1)
5	External SIO communication activity (Port 2)

LED	Description
R1	Reader 1 Clock/Data or D1/D0 mode: Flashes when Data is Received, either input F/2F mode: Flashes when Data/Acknowledgment is Received RS-485 mode: Flashes when Transmitting Data
R2	Reader 2 Clock/Data or D1/D0 mode: Flashes when Data is Received, either input F/2F mode: Flashes when Data/Acknowledgment is Received RS-485 mode: Flashes when Transmitting Data
ETH ACT	D1200 flashes with Ethernet activity
YEL	Ethernet Speed: OFF = 10Mb/S, ON = 100Mb/S
GRN	OFF= No link, ON = Good link, Flashing = Ethernet activity
IN1 - IN8	OFF = Inactive, ON = Active, Flash = Fault *
OUT1 - OUT4	Relay K1 - K4: ON = Energized

\* If this input is defined, every three seconds the LED is pulsed to its opposite state for 0.1 seconds; otherwise, the LED is off.

## Specifications

The LNL-M4420 is for use in low voltage, Class 2 circuits only. All output circuits are Class2/Power Limited. The installation of this device must comply with all local fire and electrical codes. Units are to be installed in accordance with NFPA 70. The unit is to be powered with a UL-listed UL 294 approved power supply with a class 2 power limited output.

---

**Note:** Only 12 VDC input was evaluated by UL by connection to the separately UL Listed power supplies.

---

Primary Power:	12 to 24 VDC ± 10%, 550 mA maximum (reader and USB ports not included)
Reader Ports:	600 mA maximum per reader port (add 600 mA to primary power current)
Micro USB Port:	5 VDC, 500 mA maximum (add 270 mA to primary power current) Not evaluated by UL
Memory and Clock Backup Battery:	Super capacitor or optional 3 Volt Lithium, type Panasonic BR2032 or CR2032
microSD Card	Format: microSD or microSDHC; 2GB to 8GB
Host Communication:	Ethernet: 10Base-T/100Base-TX and Micro USB port (2.0) with optional adapter: pluggable model USB2-OTGE100
Serial I/O Device	Two each: 2-wire RS-485, 2,400 to 115,200 bps, asynchronous, half-duplex, 1 start bit, 8 data bits, and 1 stop bit
Inputs:	Eight unsupervised/supervised, standard EOL: 1k/1k ohm, 1%, ¼ watt Two unsupervised dedicated for cabinet tamper and UPS fault monitoring
Outputs:	Four relays, Form-C with dry contacts Normally open contact (NO) contact: 5 A @ 30 VDC resistive Normally closed contact (NC) contact: 3 A @ 30 VDC resistive

Reader Interface:	
Power:	12 VDC ± 10% regulated, 600 mA maximum each reader port (input voltage (VIN) must be greater than 17 VDC)
(jumper selectable) 18 AWG (when using local 12 VDC power supply)	or 12 to 24 VDC ± 10% (input voltage (VIN) passed through), 600 mA maximum per reader port
Data Inputs:	TTL compatible, F/2F or 2-wire RS-485
RS-485 Mode (OSDP):	9,600 to 115,200 bps, asynchronous, half-duplex, 1 start bit, 8 data bits, and 1 stop bit. Maximum cable length: 2000 ft. (609.6 m)
LED Output:	TTL levels, high>3 V, low<0.5 V, 5 mA source/sink maximum
Buzzer Output:	Open collector, 12 VDC open circuit maximum, 40 mA sink maximum
Cable Requirements:	
Power:	1 twisted pair, 18 AWG (when using local 12 VDC power supply)
Ethernet:	CAT-5, minimum
Reader data (TTL):	6-conductor, 18 AWG, 500 feet (150 m) maximum
Reader data (F/2F):	4-conductor, 18 AWG, 500 feet (150 m) maximum
Reader data (RS-485 OSDP):	1 twisted pair, shielded, 120 ohm impedance, 24 AWG, 2,000 ft. (610 m) maximum
Bus data (RS-485 Bus):	1 twisted pair, shielded, 120 ohm impedance, 24 AWG, 2,000 ft. (610 m) maximum
Alarm Input:	1 twisted pair, 30 ohm maximum, typically 22 AWG @ 1000 ft. (304.8 m)
Outputs	As required for the load
Environmental:	
Temperature:	Storage: -55 to +85 °C (-67° to 185° F) Operating: 0 to +70 °C (32° to 158° F)
Humidity:	5 to 95% RHNC
Mechanical:	
Dimension:	8 in. (203.2 mm) W x 6 in. (152.4 mm) L x 1 in. (25 mm) H
Weight:	10.65 oz. (302 g) nominal, board only

---

**Note:** Outputs are Power limited/class 2 when powered by external power limited/class 2 power supply model LNL-AL400ULX or LNL-AL600ULX-4CB6.

---

These specifications are subject to change without notice.

UL 294 Performance Levels Indoor use:

<b>Feature</b>	<b>Level</b>
Standby Power	I
Endurance	IV
Line Security	I
Destructive Attack	I

## UL Listed Installations

- For access control-only installations using DC power, power shall be provided by a UL 294 or UL 603, class 2 power supply with appropriate ratings.
- For burglar alarm installations, backup power is not provided. A UL 603 listed, class 2 power supply with appropriate ratings shall be used that provides a minimum four hours of standby power after notification of loss of AC power.
- Locations and wiring methods shall be in accordance with the National Electrical Code, ANSI/NFPA 70.
- Only 12 VDC input was evaluated by UL by connection to the separately UL Listed power supplies.
- For UL installation, 12 VDC input with 12 VDC pass-through shall be used.
- Reader Ports are Special Applications rated: 10.95 – 12 VDC (Reader 1) and 11.06 – 12 VDC (Reader 2).
- The following readers are to be connected:
  - BlueDiamond models: LNL-R11330-05TB, LNL-R11320-05TB, LNL-R11325-05TB
  - HID Signo models: 20, 20K, 40, 40K

## Regulatory Information

### FCC Compliance

This device complies with part 15 of the FCC Rules. Operation is subject to the following two conditions: (1) This device may not cause harmful interference, and (2) this device must accept any interference received, including interference that may cause undesired operation.

### Liability

It is expressly understood and agreed that the interface should only be used to control exits from areas where an alternative method for exit is available. This product is not intended for, nor is rated for operation in life-critical control applications. LenelS2 is not liable under any circumstances for loss or damage caused by or partially caused by the misapplication or malfunction of the product. LenelS2's liability does not extend beyond the purchase price of the product.

### Certifications

For certification information, refer to the hardware documentation for the host application.

### Product Warnings and Disclaimers

THESE PRODUCTS ARE INTENDED FOR SALE TO, AND INSTALLATION BY, AN EXPERIENCED SECURITY PROFESSIONAL. LENEL S2 CANNOT PROVIDE ANY ASSURANCE THAT ANY PERSON OR ENTITY BUYING ITS PRODUCTS, INCLUDING ANY "AUTHORIZED DEALER", IS PROPERLY TRAINED OR EXPERIENCED TO CORRECTLY INSTALL SECURITY RELATED PRODUCTS.

FOR MORE INFORMATION ON PRODUCT WARNINGS AND DISCLAIMERS, SEE THE "LENEL S2 PRODUCT WARNINGS AND DISCLAIMERS" KNOWLEDGE BASE ARTICLE IN THE LENEL S2 KNOWLEDGE BASE. THIS INFORMATION IS SUBJECT TO CHANGE WITHOUT NOTICE.